

ONKYO®

T-4711

FM Stereo / AM Tuner FM Stereo Tuner

All models except European models
(FM Stereo / AM Tuner)

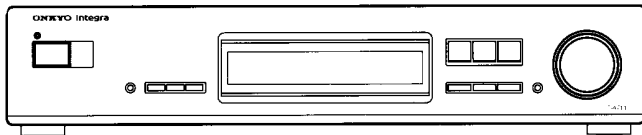

European model
(FM Stereo Tuner)

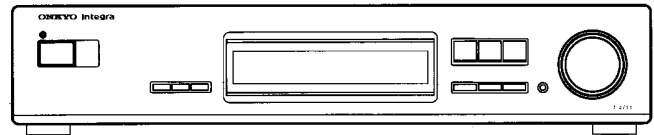

Instruction Manual

CONTENTS

Features.....	2
Important safeguards	3
Precautions.....	3
Before using this unit.....	4
System connections	5
Antenna connections.....	6
Control positions and names.....	8
Connecting the power	9
Receiving stations	10
Receiving RDS	13
Entering characters	15
Setting the clock	16
Using the timer (for remote control only).....	18
Specifications.....	20
Troubleshooting guide.....	20

Thank you for your purchase of the Onkyo T-4711 Tuner.

Please read this manual thoroughly before making connections and turning power on.

Following the instructions in this manual will enable you to obtain optimum performance and listening enjoyment from your new Tuner.

Please retain this manual for future reference.

Features

- RDS (AF, PS, PTY, TP, RT, CT, TA)
- 40 FM Random presets / 4 Groups
- 3 Modes APR (Auto Precision Reception) → IF Band, High Blend, Mode
- 4 Groups Memory
- Dial Tuning Knob
- FM Cable with 25kHz step Tuning
- 10-Segment Signal Strength Bar
- 4 Mode Timer Function (Once, WeekDay, WeekEnd, Sleep)
- ACCUCLOCK
- RI Remote Compatible

Remarks:

FM & AM available (For USA, Canada and Asia market)

FM only (For Europe market)

**FOR CANADIAN MODEL:
(POUR LE MODELE CANADIEN)**

- For models having a power cord with a polarized plug.

CAUTION: TO PREVENT ELECTRIC SHOCK, MATCH WIDE BLADE OF PLUG TO WIDE SLOT, FULLY INSERT.

- Sur les modèles dont la fiche est polarisée.

ATTENTION: POUR ÉVITER LES CHOCS ÉLECTRIQUES, INTRODUIRE LA LAME LA PLUS LARGE DE LA FICHE DANS LA BORNE CORRESPONDANTE DE LA PRISE ET POUSSER JUSQU'AU FOND.

Memory Preservation

This unit does not require memory preservation batteries. A built-in memory power back-up system preserves the contents of the memory during power failures and even when the unit is unplugged. The unit must be plugged in order to charge the back-up system.

The memory preservation period after the unit has been unplugged varies depending on climate and placement of the unit. On the average, memory contents are protected over a period of a few weeks after the last time the unit has been unplugged. This period is shorter when the unit is exposed to a highly humid climate.

Declaration of Conformity

We, ONKYO EUROPE
ELECTRONICS GMBH
INDUSTRIESTRASSE 18/20
82110 GERMERING,
GERMANY



declare in own responsibility, that the ONKYO product described in this instruction manual is in compliance with the corresponding technical standards such as EN55013, EN55020, EN60555-2, EN60065

GERMERING, GERMANY

H. YAMAZOE

ONKYO EUROPE ELECTRONICS GMBH

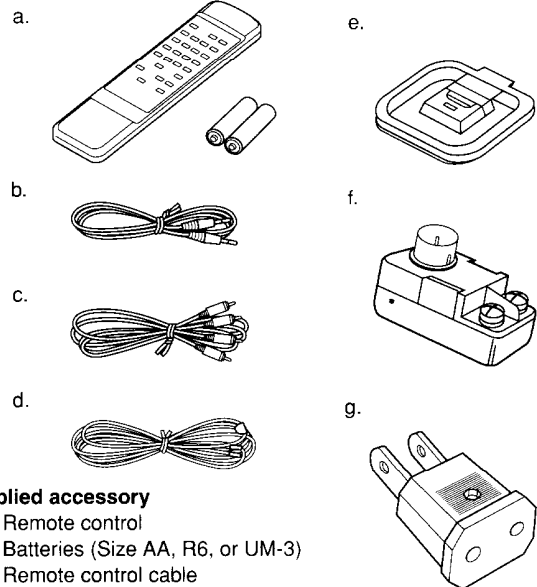

Supplied accessory

- a. 1 Remote control
- 2 Batteries (Size AA, R6, or UM-3)
- b. 1 Remote control cable
- c. 1 Audio connection cable
- d. 1 T-shaped FM antenna
- e. 1 AM loop antenna (For models other than European models)
- f. 1 75/300 ohm antenna adaptor (For models other than European models)
- g. 1 Conversion plug (Worldwide model only)



CAUTION
RISK OF ELECTRIC SHOCK
DO NOT OPEN



- The lightning flash with arrowhead symbol, within an equilateral triangle, is intended to alert the user to the presence of uninsulated "dangerous voltage" within the product's enclosure that may be of sufficient magnitude to constitute a risk of electric shock to persons.
- The exclamation point within an equilateral triangle is intended to alert the user to the presence of important operating and maintenance (servicing) instructions in the literature accompanying the product.

"WARNING"

"TO REDUCE THE RISK OF FIRE OR ELECTRIC SHOCK, DO NOT EXPOSE THIS APPLIANCE TO RAIN OR MOISTURE."

CAUTION:

"TO REDUCE THE RISK OF ELECTRIC SHOCK, DO NOT REMOVE COVER (OR BACK). NO USER-SERVICEABLE PARTS INSIDE. REFER SERVICING TO QUALIFIED SERVICE PERSONNEL."

Important safeguards

1. **Read Instructions** – All the safety and operating instructions should be read before the appliance is operated.
2. **Retain Instructions** – The safety and operating instructions should be retained for future reference.
3. **Heed Warnings** – All warnings on the appliance and in the operating instructions should be adhered to.
4. **Follow Instructions** – All operating and use instructions should be followed.
5. **Water and Moisture** – The appliance should not be used near water – for example, near a bathtub, washbowl, kitchen sink, laundry tub, in a wet basement, or near a swimming pool, and the like.
6. **Carts and Stands** – The appliance should be used only with a cart or stand that is recommended by the manufacturer.
 - 6A. An appliance and cart combination should be moved with care. Quick stops, excessive force, and uneven surfaces may cause the appliance and cart combination to overturn.



7. **Wall or Ceiling Mounting** – The appliance should be mounted to a wall or ceiling only as recommended by the manufacturer.
8. **Ventilation** – The appliance should be situated so that its location or position does not interfere with its proper ventilation. For example, the appliance should not be situated on a bed, sofa, rug, or similar surface that may block the ventilation openings; or if placed in a built-in installation, such as a book case or cabinet that may impede the flow of air through the ventilation openings, there should be free space of at least 20 cm and open up behind the appliance.
 - **Heat** – The appliance should be situated away from heat sources such as radiators, heat registers, stoves, or other appliances (including amplifiers) that produce heat.
10. **Power Sources** – The appliance should be connected to a power supply only of the type described in the operating instructions or as marked on the appliance.
11. **Polarization** – If the appliance is provided with a polarized plug having one blade wider than the other, please read the following information: The polarization of the plug is a safety feature. The polarized plug will only fit the outlet one way. If the plug does not fit fully into the outlet, try reversing it. If there is still trouble inserting it, the user should seek the services of a qualified electrician. Under no circumstances should the user attempt to defeat the polarization of the plug.
12. **Power-Cord Protection** – Power-supply cords should be routed so that they are not likely to be walked on or pinched by items placed upon or against them, especially near plugs, convenience receptacles, and the point where they exit from the appliance.
13. **Cleaning** – The appliance should be cleaned only as recommended by the manufacturer.
14. **Power Lines** – An outdoor antenna should be located away from power lines.
15. **Nonuse Periods** – The power cord of the appliance should be unplugged from the outlet when left unused for a long period of time.
16. **Object and Liquid Entry** – Care should be taken so that objects do not fall and liquids are not spilled into the enclosure through openings.
17. **Damage Requiring Service** – The appliance should be serviced by qualified service personnel when:
 - A. The power-supply cord or the plug has been damaged; or
 - B. Objects have fallen, or liquid has been spilled into the appliance; or
 - C. The appliance has been exposed to rain; or
 - D. The appliance does not appear to operate normally or exhibits a marked change in performance; or
 - E. The appliance has been dropped, or the enclosure damaged.

18. **Servicing** – The user should not attempt to service the appliance beyond that described in the operating instructions. All other servicing should be referred to qualified service personnel.
19. **Outdoor Antenna Grounding** – If an outside antenna is connected to the receiver, be sure the antenna system is grounded so as to provide some protection against voltage surges and built up static charges. Article 810 of the National Electrical Code, ANSI/NFPA 70, provides information with regard to proper grounding of the mast and supporting structure, grounding of the lead-in wire to an antenna discharge unit, size of grounding conductors, location of the antenna-discharge unit, connection to grounding electrodes, and requirements for the grounding electrode. See Figure 73.1.

FIGURE 73.1:
EXAMPLE OF ANTENNA GROUNDING AS PER NATIONAL ELECTRICAL CODE

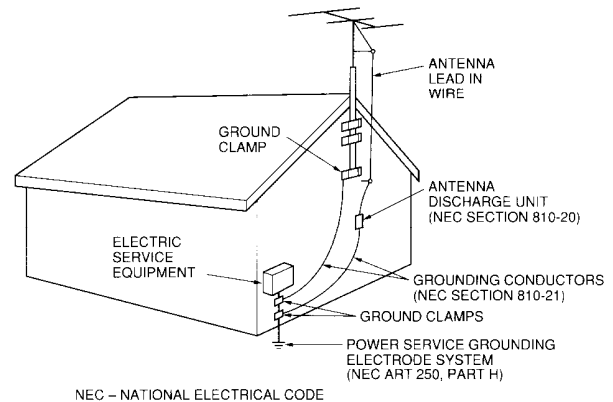

NEC – NATIONAL ELECTRICAL CODE
S2898A

Precautions

1. Warranty Claim

You can find the serial number of the rear panel. In case of warranty claim, please report this number.

2. Care

From time to time you should wipe the front and rear panels and the cabinet with a soft cloth. For heavier dirt, dampen a soft cloth in a weak solution of mild detergent and water, wring it out dry, and wipe off the dirt. Following this, dry immediately with a clean cloth. Do not use rough material, thinners, alcohol or other chemical solvents or cloths since these could damage the finish or remove the panel lettering.

3. Power

WARNING

BEFORE PLUGGING IN THE UNIT FOR THE FIRST TIME, READ THE FOLLOWING SECTION CAREFULLY.

- Some models are designed for use only with the power supply voltage of the region where they are sold.

U.S.A. and Canadian models:	AC 120 V, 60 Hz
European model:	AC 230 V, 50 Hz
Worldwide model:	AC 120 V/220 – 230 V switchable, 50/60 Hz

- **Voltage Selector (Rear Panel)**

Worldwide models are equipped with a voltage selector to conform with local power supplies. Be sure to set this switch to match the voltage of the power supply in your area before turning the power button on. (See “Setting the voltage selector and Tuning step frequency (Worldwide models only)”, P. 4.) Models without a voltage selector can only be used in areas where the power supply is the same as that of the unit.

Before using this unit

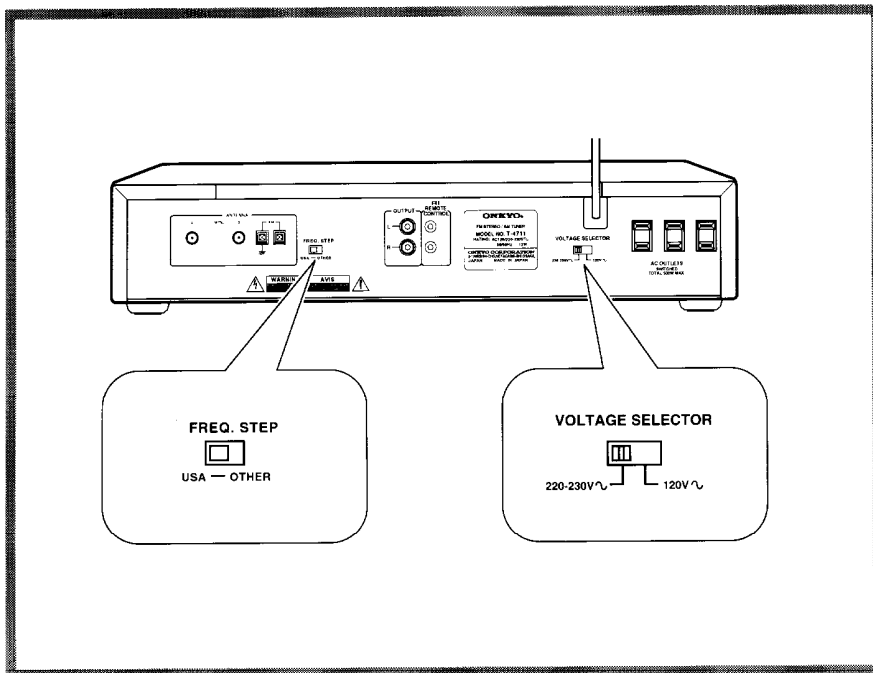

Setting the voltage selector and Tuning step frequency (Worldwide models only)

Voltage selector

1. Determine the proper voltage for your area: 220 – 230 V or 120 V.
2. If the preset voltage is not correct for your area, insert a screwdriver into the groove in the switch. Slide the switch all the way to the right (120 V) or to the left (220 – 230 V), whichever is appropriate.

Tuning step frequency

Worldwide models are equipped with a switch that controls the AM (9 kHz/10 kHz) and FM (50 kHz/200 kHz) bands tuning steps. Please set this switch to match the tuning step frequency in your area.

U.S.A. : AM 10 kHz, FM 200 kHz
(25 kHz, Fine mode)

Other areas : AM 9 kHz, FM 50 kHz
(25 kHz, Fine mode)

Please insert the batteries into the remote control according to the illustration.

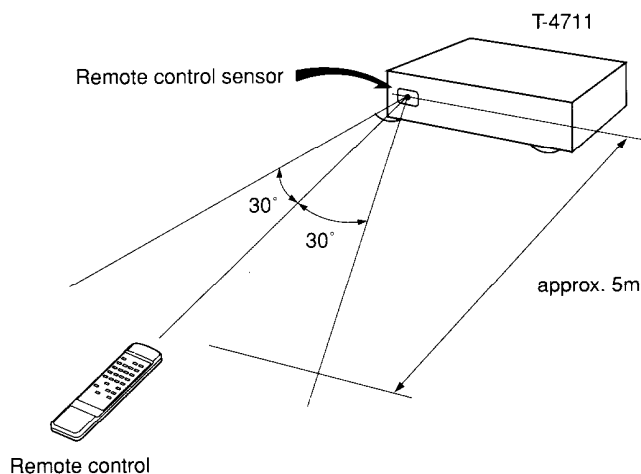
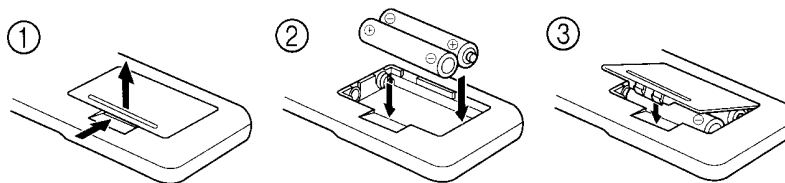

Inserting the remote control batteries

Remove the battery compartment cover by opening it as shown in the illustration. Load three R6 (UM-3) AA size batteries into the remote control with the plus (+) and minus (-) terminals positioned as indicated by the diagram inside the battery compartment and close the cover.

- Remove dead batteries immediately to avoid corrosion damage.
- To avoid potential corrosion damage, never mix old batteries with new ones.
- The manganese batteries supplied with this unit have a service life of approximately six months, depending on frequency of usage.
- This unit comes equipped with R6 (UM-3) AA manganese batteries, but we recommend that long-life alkaline batteries LR6 (AM-3) AA be used when replacing the batteries.

Using the remote control

The following information will help you get optimum use from the remote control.

- Place this unit away from direct bright light, which can prevent proper operation of the remote control.
- Make sure audio rack doors do not have coloured glass. If this unit is placed behind such a door, this may prevent proper remote control operation.
- Using other remote controls in the same room as this unit remote control may cause interference.

System connections

- Do not plug in the power cord until all connections have been made.
- On each pair of input or output jacks, the lower jack (marked R) corresponds to the right channel, and the upper jack (marked L) to the left channel.

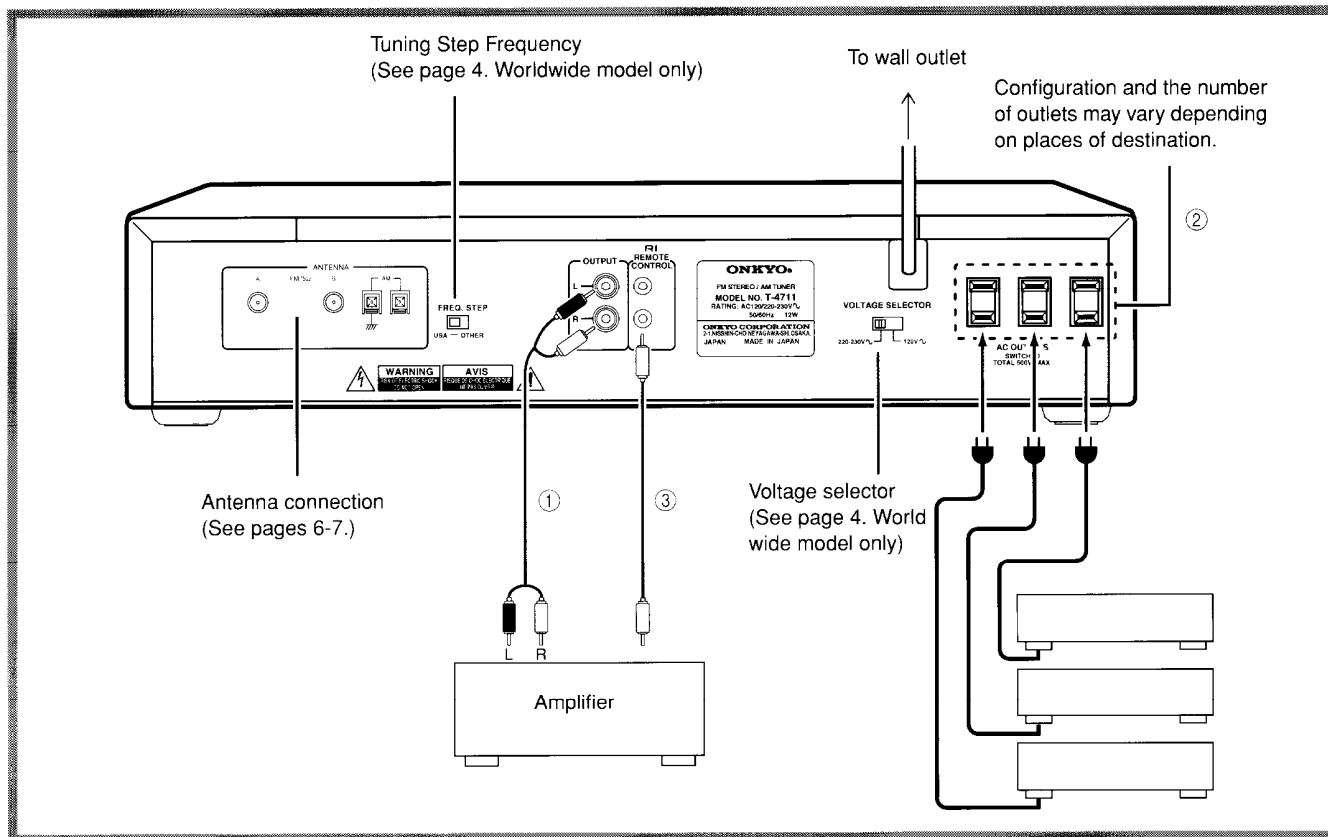

① Connecting the amplifier:

Connect the tuner's OUTPUT jacks and the amplifier's INPUT jacks using the audio connection cable. Refer to the amplifier's instruction manual for connections.

② AC outlets (SWITCHED)

The shape, orientation, the number and total capacity of the AC outlets may differ according to the model and the area where the unit is purchased. Be careful that other components connected to this unit do not exceed the capacity that is printed on the rear panel below under the AC outlets.

When connecting other Integra series components (such as the A-9911/9711, DX-7911/7711 or TA-6711), connect the power cords of those components to this unit's AC outlets.

The unit may be turned ON or OFF according to the setting of POWER button, ON or OFF, respectively.

When this unit is used as a timer, the other components that will be switched on and off should be connected to this unit's AC outlets.

③ Connections for remote control

When this is connected to an amplifier with the Onkyo RI jack, you are able to operate it by pressing the TUNER buttons on the amplifier's supplied remote control.

NOTE:

An RI remote control cable equipped with a 1/8" (3.5 mm) diameter miniature two-conductor phone plug is included with this unit and with every compact disc player and cassette deck with the RI mark.

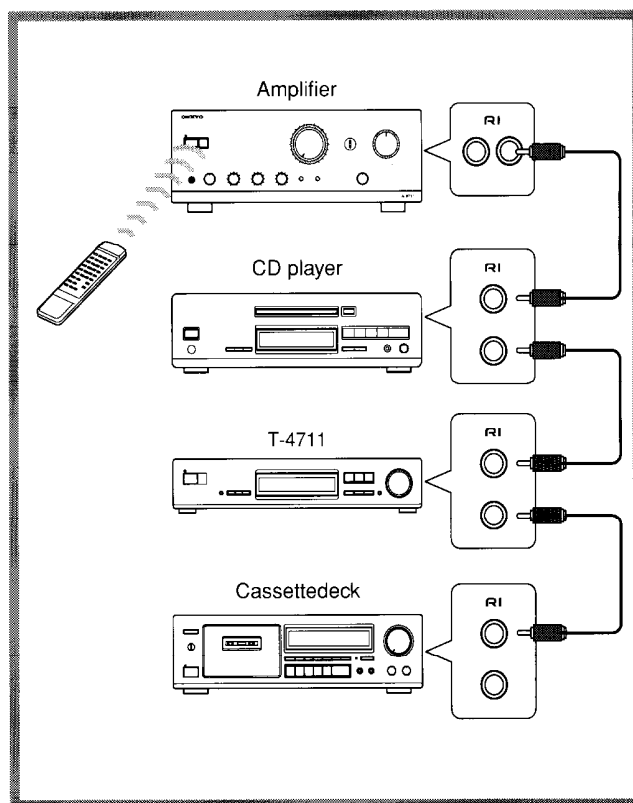

Antenna connections

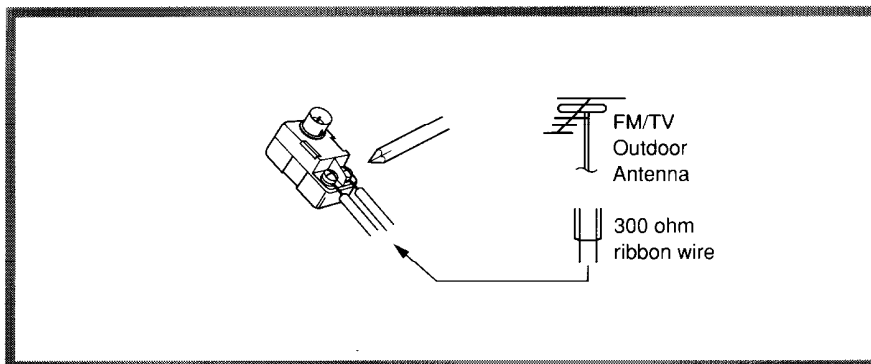

Connecting the 300 ohm ribbon wire to the 75/300 ohm adaptor (for models other than European models)

Loosen the screws and wrap the wire around these screws. Then tighten the screw with a screwdriver.

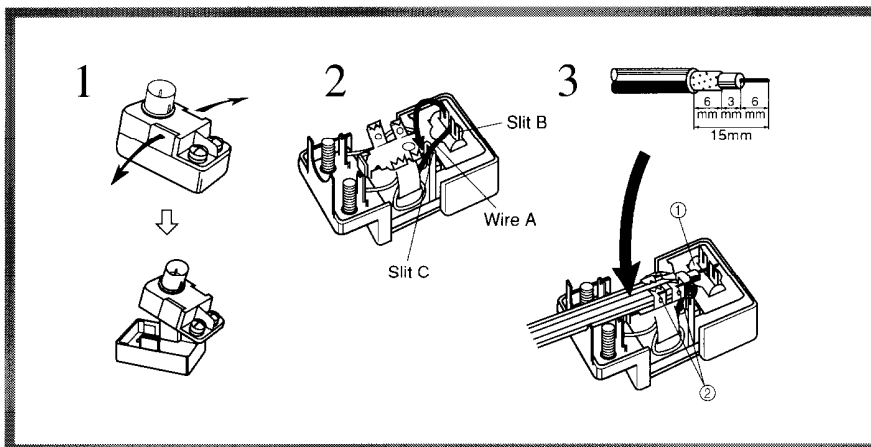

Connecting the coaxial cable to the 75/300 ohm adaptor (for models other than European models)

1. With your fingernail or a small screwdriver, press the stoppers outwards and remove the cover.
2. Remove the transformer wire A from slit B and insert it into slit C.
3. Prepare the coaxial cable as shown in the diagram. Connect the 75/300 ohm antenna adaptor to the coaxial cable.

- ① Insert the end of the cable.
- ② Clamp it in place with pliers.

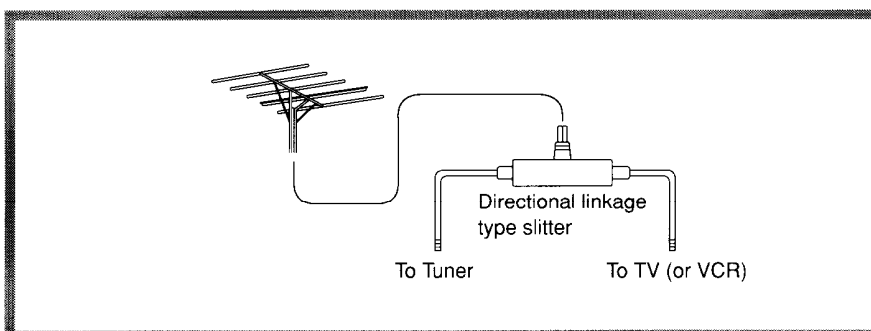

Directional linkage

Do not use the same antenna for both FM and TV (or VCR) reception since the FM and TV (or VCR) signals can interfere with each other. If you must use a common FM/TV (or VCR) antenna, use a directional linkage type splitter.

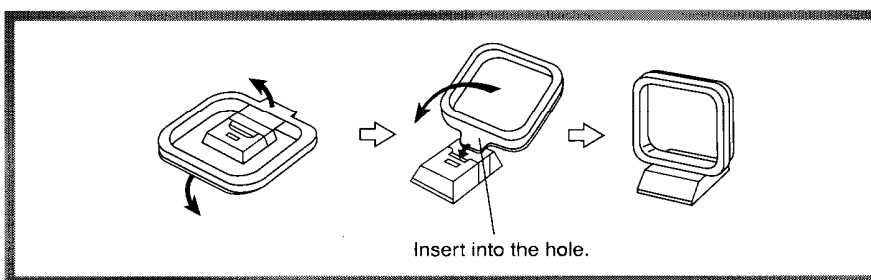

Assembling the AM loop antenna

Assemble the loop antenna as shown in the illustration.

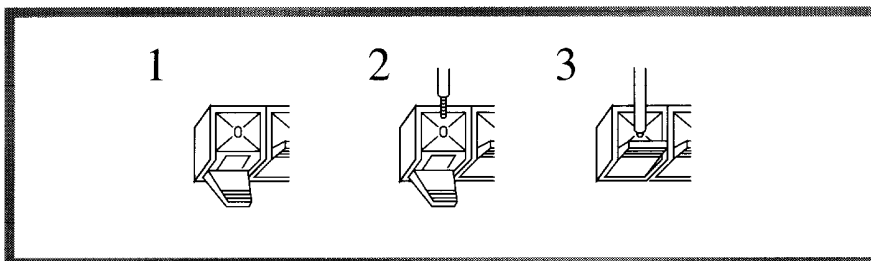

Connecting the antenna cable

1. Press down the lever.
2. Insert wire.
3. Return the lever.

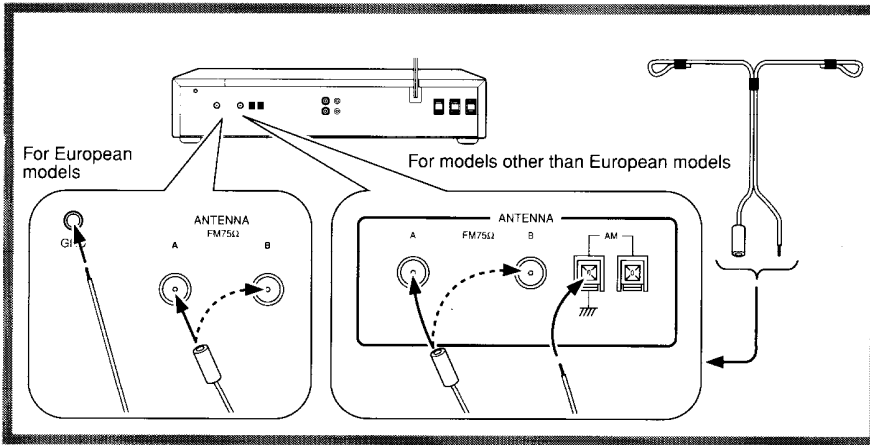

Connecting the enclosed T-shaped FM antenna

The T-shaped FM antenna is for indoor use only. Extend the antenna and move it in various directions until the clearest signal is received. Fix it with push pins or similar in the position giving the least amount of distortion.

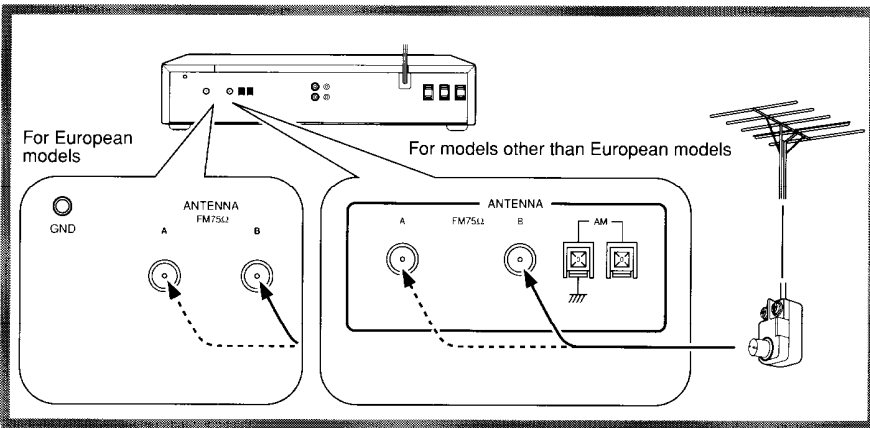

Connecting an FM outdoor antenna

If the reception is not very clear with the attached T-shaped FM antenna, the use of an external antenna is recommended. Please make sure that you comply with the following considerations regarding the location. Keep the antenna away from noise sources (neon signs, busy roads etc.) It is dangerous to put it close to power lines, so keep it well away from power lines, etc.

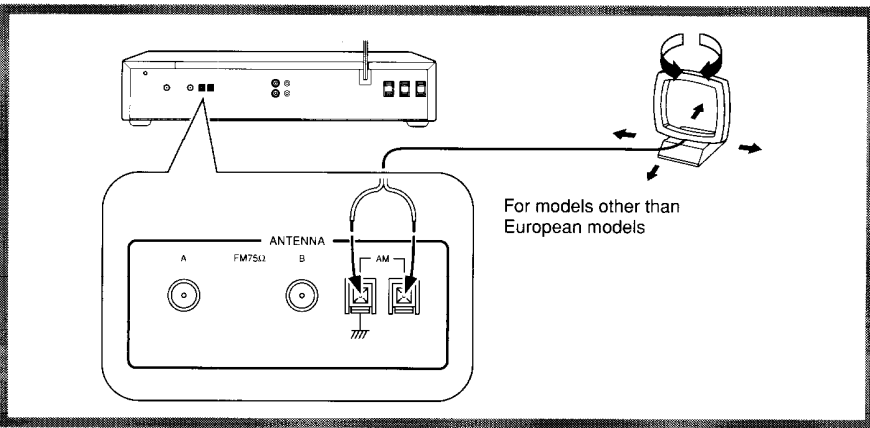

Connecting the enclosed AM loop antenna (For models other than European models)

The AM loop antenna is for indoor use only. Set in the direction and position where you receive the clearest sound. Put it as far as possible away from the main unit, TV set, speaker cables and power cord.

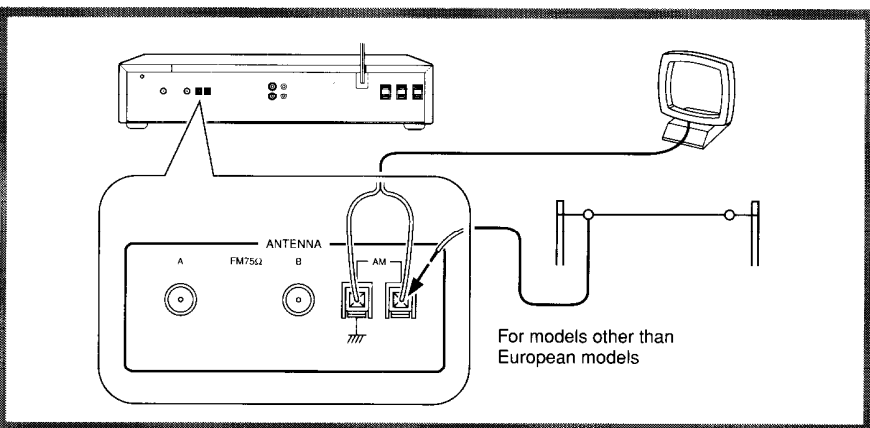

Connecting an AM outdoor antenna (For models other than European models)

When reception is not satisfactory by the use of the attached AM loop antenna alone, connection of the external antenna is recommended. (Do not remove the AM loop antenna) The external antenna will be more effective if you stretch it horizontally in a high place above a window or outside.

Control positions and names

Front Panel

The button positions may differ slightly depending on the country of purchase.

(For models other than European models)

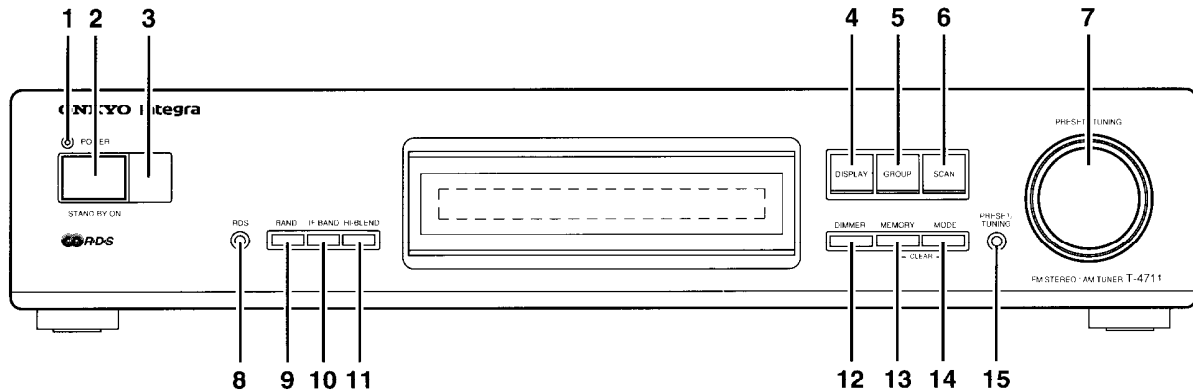

(For European models)

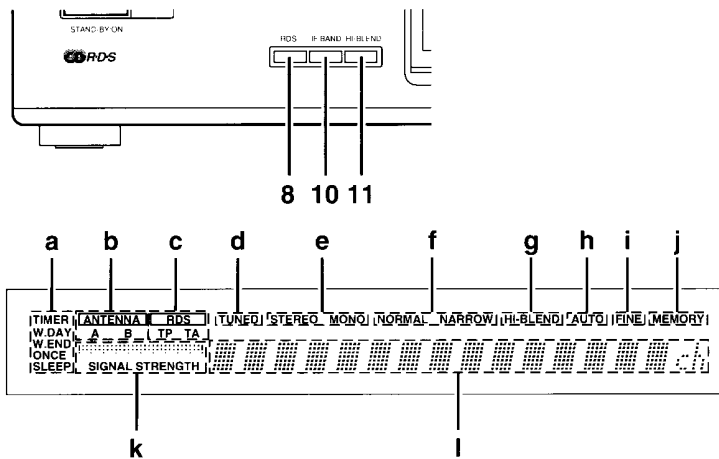

NOTE:

If there is a protective film on the surface of the display, which is making it difficult to read the display, remove it.
For more information about buttons, turn to the page number in the [].

Front Panel

1. Power Indicator
2. Power Button (POWER) [9, 18]
3. Remote Control Sensor [4]
4. Display Button (DISPLAY) [12, 14]
5. Group Button (GROUP) [10, 11]
6. Scan Button (SCAN) [13, 14]
7. Preset/Tuning Dial (PRESET/TUNING) [10, 11, 15]
8. RDS Button (RDS) [13, 14]
9. Band Selector Button (BAND) [10]
- (* Not available on the European model)
10. IF Bandwidth Selector Button (IF BAND) [12]
11. Hi-Blend Selector Button (HI-BLEND) [12]
12. Dimmer Button (DIMMER) [11]
13. Memory Button (MEMORY) [10, 11, 15]
14. Mode Button (MODE) [11, 12, 15, 18, 19]
15. Preset/Tuning Button (PRESET/TUNING) [10, 11, 15]

The display and indicator

- a. Timer Mode Indicators
- b. Antenna Indicators
- c. RDS Indicators
- d. Tuned Indicator
- e. Stereo/Mono Indicator
- f. IF-Bandwidth Indicator
- g. Hi-Blend Indicator
- h. Auto Tuning Indicator
- i. Fine Tuning Indicator
- j. Memory Indicator
- k. Signal strength level Display
- l. Multi Display

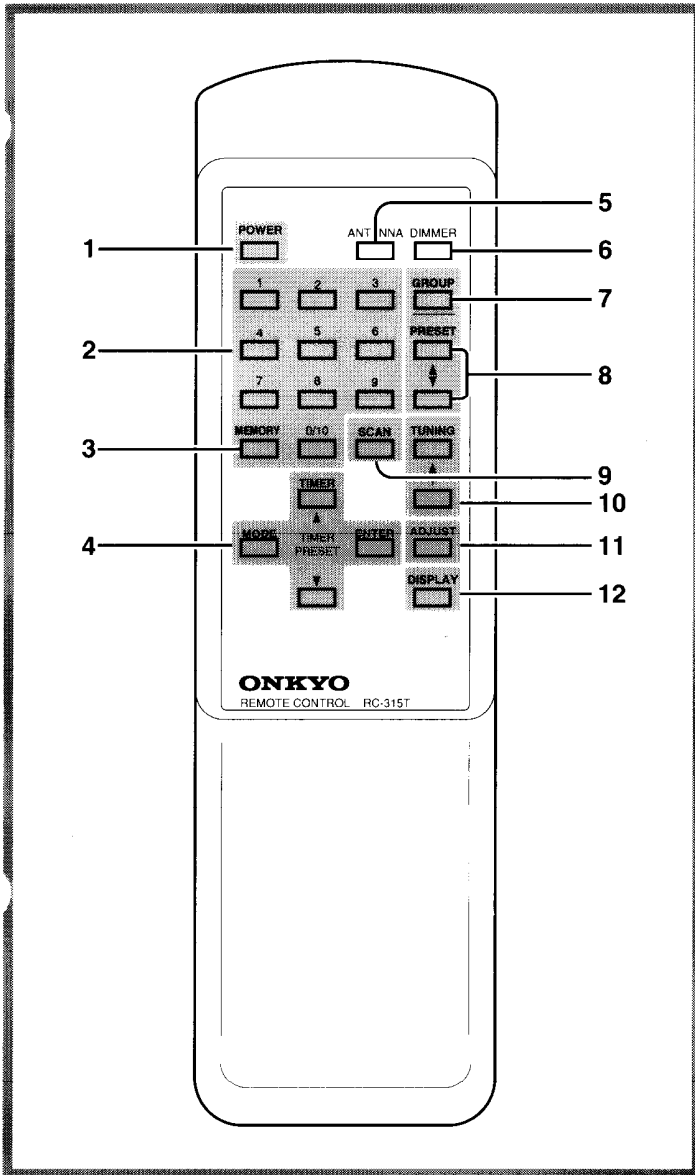

Remote control

1. Power Button (POWER) [9, 18]
2. Number Buttons (1 - 9, 0/10) [10, 17]
3. Memory Button (MEMORY) [10, 11, 15]
4. Timer preset Buttons (TIMER PRESET) [16, 17, 18]
5. Antenna Selector Button (ANTENNA) [10, 12]
6. Dimmer Button (DIMMER) [11]
7. Group Button (GROUP) [10, 11]
8. Preset memory up/down Buttons (PRESET ▲/▼) [11]
9. Scan Button (SCAN) [13, 14]
10. Tuning up/down Buttons (TUNING ▲/▼) [10]
11. Adjust Button (ADJUST) [16, 17]
12. Display Button (DISPLAY) [12, 14]

Connecting the power

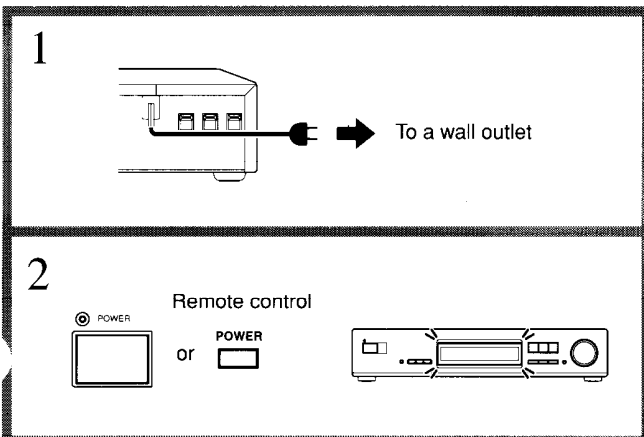

1. Insert the AC power supply cord into a wall outlet. "0:00" flashes.
2. When you press the POWER button, the display will light.

Receiving stations

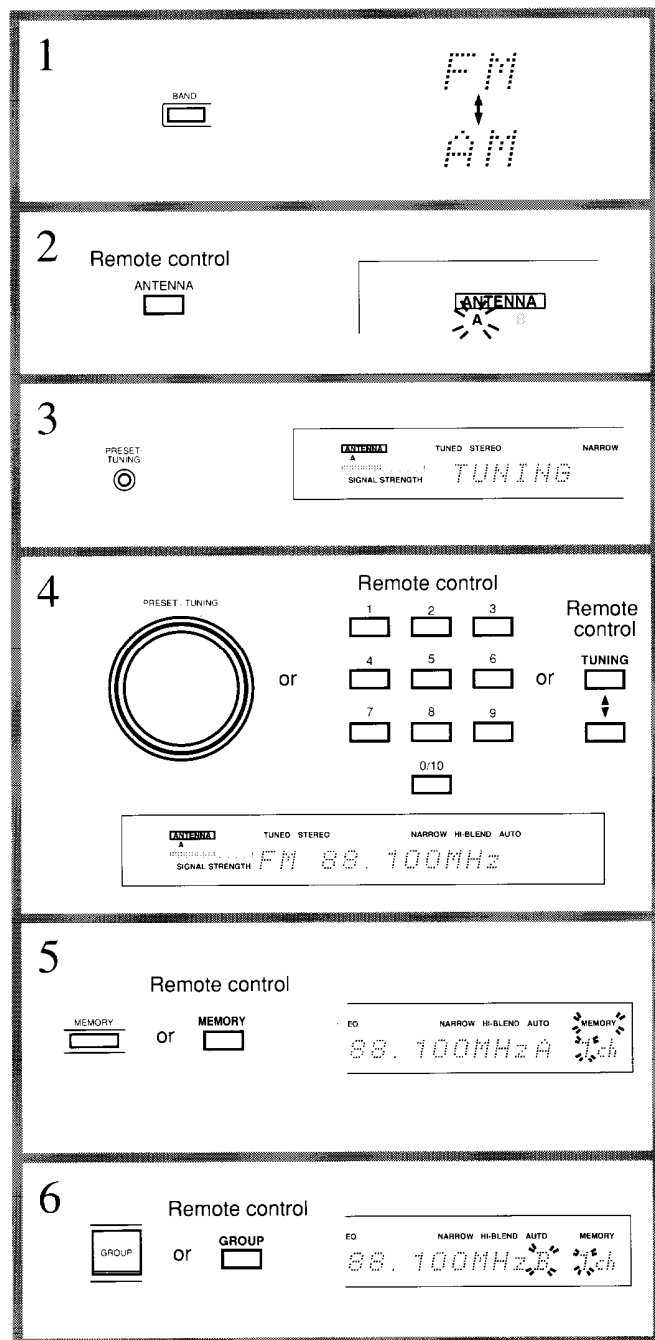
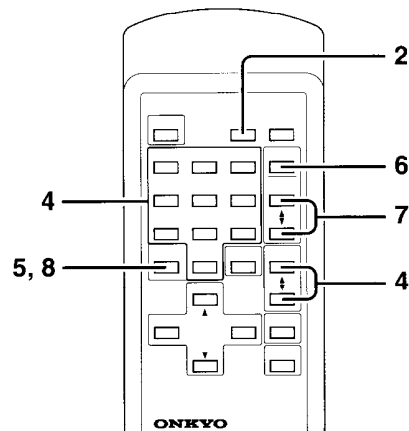
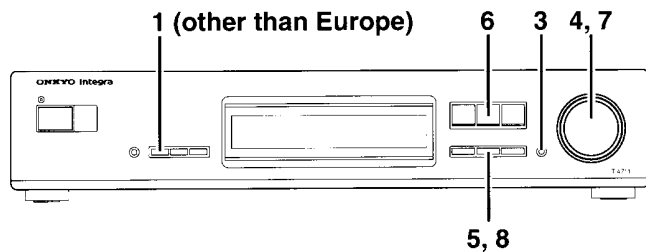

In order to listen to a radio broadcast, first tune in the radio station, then set it. The radio station can be selected in two ways: by using the auto-tuning function or by directly entering the station's frequency. When tuning in the radio station, refer to page 12 for more information on how to get the best reception possible.

Tuning the radio and presetting stations

- (For models other than European models) Use the **BAND** button to select either FM or AM.
- (When selecting an FM station) Use the **ANTENNA** button on the remote control to select the antenna.
- Press the **PRESET/TUNING** button until Tuning Mode is selected.

- With each press of the button, the mode changes one at a time in the following sequence:

→ PRESET → TUNING → CHARACTER

Continue pressing the **PRESET/TUNING** button until "TUNING" appears on the display.

- When using the remote control, press the **TUNING** ▲/▼ buttons.
- Tune in the station.**
To tune in a station using the PRESET/TUNING dial:
 Turn the **PRESET/TUNING** dial either clockwise or counterclockwise to begin auto-tuning. Once a station is tuned in, auto-tuning will stop. When using the remote control, hold down the **TUNING** ▲ or ▼ button for more than 0.5 second to begin auto-tuning.
 - To select another station, turn the **PRESET/TUNING** dial again and the next station will be tuned in.
 - If the station's frequency is weak and auto-tuning is not be able to tune it in, refer to page 12.

To tune in a station by directly entering the station's frequency:

- Use the number buttons to enter the station's frequency.
- For example, if the station frequency is 88.10 MHz, press 8 twice, then press 1, and then 0.
- If no radio station can be received at the entered frequency, the unit will decrease the frequency until the station nearest to the entered frequency is received.
- If you have accidentally entered the wrong frequency, try entering the correct frequency again.

- Press the **MEMORY** button. The **MEMORY** indicator will light up and the number of an available preset channel will flash on the display.

- Use the **GROUP** buttons to select the group in which you wish to preset the station.

You can select from A, B, C or D.

(Continued on page 11)

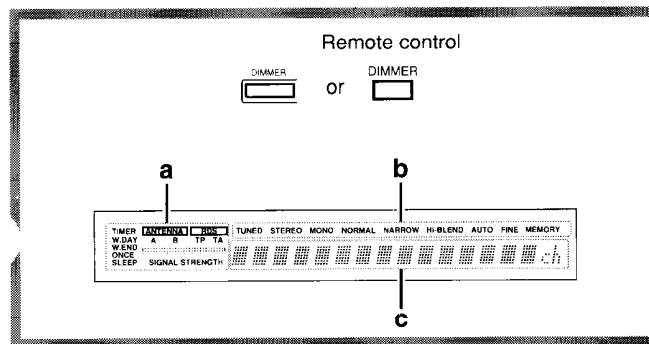
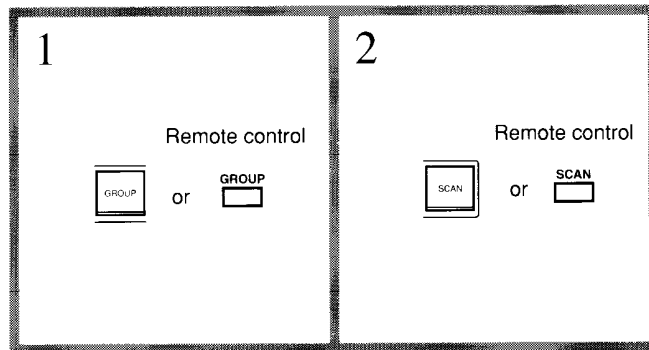
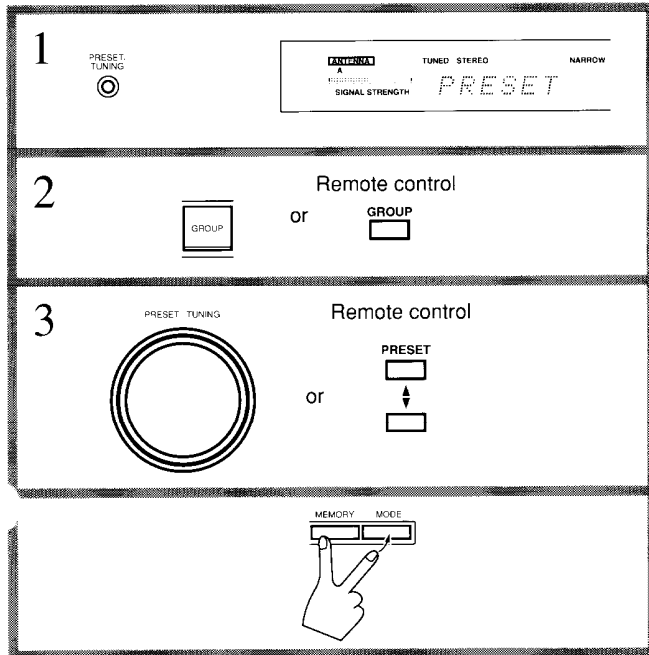
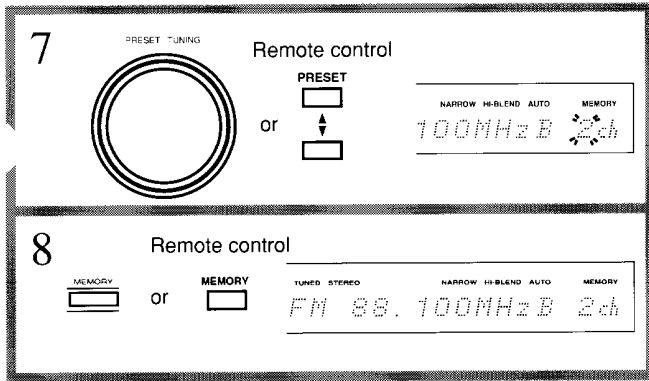

- When the flashing channel is not the desired channel, turn the PRESET/TUNING dial and select a different channel.
 - If a station frequency has already been memorized in the selected channel, the channel number will flash quickly.
 - Each group contains ten channels.
 - The channel can also be entered using the number buttons on the remote control. If this is done, skip step 8.
- Press the MEMORY button.

NOTE:

- 40 channels are available for storing preset stations.

Selecting a preset station

- Press the PRESET/TUNING button until Preset Mode is selected.

With each press of the button, the mode changes one at a time in the following sequence:



Continue pressing the PRESET/TUNING button until "PRESET" appears on the display.

Skip this step if the remote control is used.

- Use the GROUP button to select a group (A ~ D).
- Use the PRESET/TUNING dial to select the desired channel.

To select a preset station using the remote control: Press the PRESET ▲/▼ buttons.

To cancel a preset station:

- Select the preset station as explained in the previous section.
- While holding the MEMORY button, press the MODE button. "--" will be shown on the MEMORY channel display.

Scanning through the preset channels (Preset Scan Tuning)

- Press the GROUP button, then select the group that you wish to scan.
- Press the SCAN button.
 - The stations in the preset channels are played one after another for a few seconds each. Once you have found a station that you wish to continue listening to, press the SCAN button again to stop scanning.
 - If only one station has been stored in the selected group, the channels are not scanned.

Using the DIMMER button

The part of the display that is lit up changes with each press of the DIMMER button in the following sequence: Entire display lights up → Section [a] goes off → Section [b] also goes off → Entire display goes off → Entire display lights up...

If the DIMMER button is pressed in stand-by mode:

In stand-by mode, each press of the DIMMER button changes the time display to one of the four brightness levels.

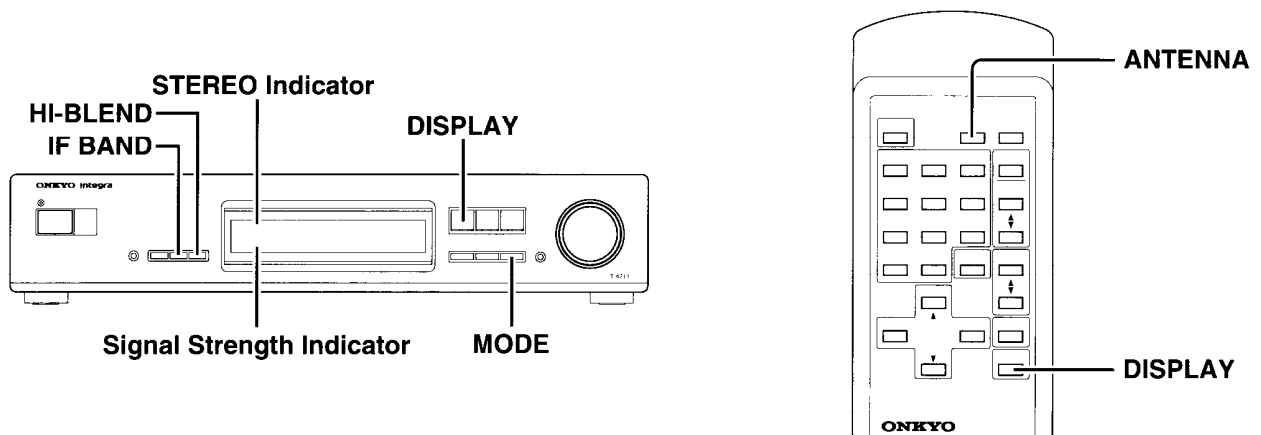

Getting a better FM reception

■ APR (Automatic Precision Reception) System

The APR system is Onkyo's unique computer-controlled system which automatically chooses the appropriate settings according to the quality of the FM signal currently being received. This system selects the appropriate Mode (STEREO or MONO), turns on the Hi-blend function when the stereo broadcast contains noise in its higher frequencies, and switches the IF band function to NARROW when the FM station signal is mixed with interference from other stations.

- If the FM broadcast is received as a monaural signal, the STEREO indicator goes off.
- If the quality of the signal changes once the APR system has adjusted the settings, the APR system will not automatically readjust the settings. Change the settings by pressing the buttons (IF BAND, HI-BLEND, MODE) on the main unit.

■ IF BAND button

When FM stations are mixed or there is interference, this button corrects this as much as possible. Each press switches it as follows: NORMAL/NARROW.

Normal mode (NORMAL) is selected for normal reception. Narrow mode (NARROW) is selected when other stations may be at frequencies that are close to the desired station.

NOTE:

Depending on the radio station signal, it may be difficult to receive RDS broadcasts when IF BAND is set to NARROW. If this is the case, set IF BAND to NORMAL.

■ HI-BLEND button

Weak FM stations may exhibit noisy and hissy sound quality in stereo mode. The high blend circuit blends only the highest frequencies into mono, while the rest of the audio range remains in stereo, with substantially reduced noise and hiss.

Each press switches between ON or OFF.

■ MODE button

If an AM station is being received, this button switches the mode between auto-tuning and manual tuning.

If an FM station with a very weak and noisy signal is received, improve the situation by switching to monaural, even if it is a stereo broadcast. At this time, the MONO indicator will light up. When it is noisy, turning ON HI-BLEND is also effective.

The three settings that can be selected with the MODE button can be used to improve the reception of FM stations with weak signals.

Auto tuning setting ("AUTO" lights up.): Turn the PRESET/TUNING dial to begin auto-tuning. The frequency changes in steps of 50 kHz (or 200 kHz) when tuning an FM station or in steps of 9 kHz (or 10 kHz) when tuning an AM station.

- * The steps in which the frequency is changed differ according to the country of purchase. The frequency steps shown in () are for the USA and Canadian model.

Manual fine setting ("FINE" lights up.): Turn the PRESET/TUNING dial to manually tune in the station. The FM frequency changes in steps of 25 kHz.

Manual fine monaural setting ("FINE" and "MONO" light up.): This setting is like the previous one, except it plays the broadcast in MONO so that even a station with a weak signal can be received.

■ ANTENNA Button

If antennas have been connected to both the A and B FM antenna connectors on the rear panel, select the one with better sensitivity using the ANTENNA button on the remote control.

The antenna A/B selection status will be memorized at the Preset Station Buttons.

■ FM Stereo Indicator (STEREO)

This indicator lights up when an FM stereo broadcast is being received. It does not light when a weak FM stereo broadcast is being received.

■ Signal Strength Indicator

Optimum tuning points are indicated by the number of lighted segments.

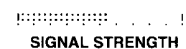

Hold down the DISPLAY button to display "FM Signal" and the signal strength in decibels (dB).

■ Displaying station information

During FM reception of any RDS station with PS, or when characters are being entered, the PS, or character information is displayed.

When you want to see the frequency, press the DISPLAY button. Press it again to return to the original display.

If there is no PS or character display, the frequency will be displayed.

Receiving RDS

RDS reception is only available in areas where RDS broadcasts are available. However, if radio reception is weak, RDS may not be received.

What is RDS?

Many FM stations now transmit RDS signals which give additional information. RDS provides you with various services so that (for example) you can choose a station broadcasting your favorite categories of music, or other information. The information below is available on this unit.

- PS:** Program Service Name
- PTY:** Program Type
- TP:** Traffic Program
- AF:** Alternative Frequency list
- RT:** Radio Text
- CT:** Clock Time

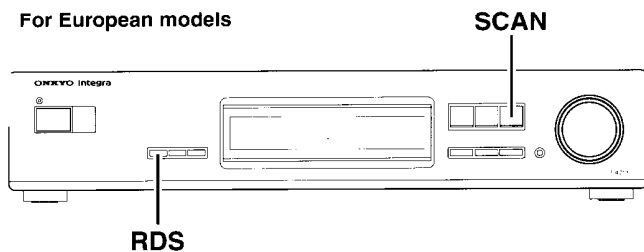
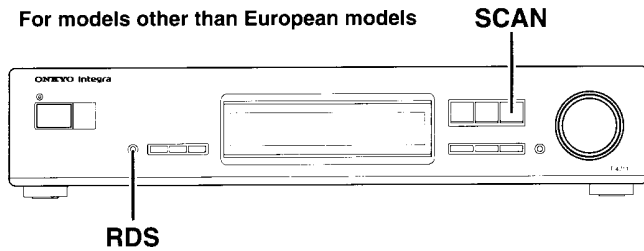

1	(For models other than European models) (For European models)
2	
3	
4	

PTY Classifications in USA

1. NEWS
2. Information
3. Sports
4. Talk
5. Rock
6. Classic Rock
7. Adult Hits
8. Soft Rock
9. Top 40
10. Country
11. Oldies
12. Soft
13. Nostalgia
14. Jazz
15. Classical
16. R & B
17. Soft R & B
18. Language
19. Religious Music
20. Religious Talk
21. Personality
22. Public

* **Alert:** When an RDS station is making an emergency broadcast, this PTY will appear on the display, and flash on and off.

PTY Classifications in Europe

1. NEWS (News reports)
2. Current Affairs (Current Affairs)
3. Information (Information)
4. Sport (Sport)
5. Education (Education)
6. Drama (Drama)
7. Culture (Culture)
8. Science (Science and technology)
9. Varied (Varied)
10. Pop Music (Pop Music)
11. Rock Music (Rock Music)
12. M.O.R. Music (Middle of the road music)
13. Light Classics (Light Classics)
14. Serious Classics (Serious Classics)
15. Other Music (Other Music)

* **Alarm:** When an RDS station is making an emergency broadcast, this PTY will appear on the display, and flash on and off.

How to search for a station which broadcasts your favorite category (PTY scan)

1. Press the RDS button, and the program type of the currently selected station will be shown on the display. If the station you are receiving is not broadcasting RDS, "Prog Type?" will be shown on the display.
2. Use the PRESET/TUNING dial to select your favorite program type (PTY) (for example, "Sport"). See the PTY description below.
3. Press the SCAN button to start searching for the chosen PTY. When a station is received with the desired PTY, the scanning stops for approximately 5 seconds, before the unit starts scanning again.
4. When the desired station is reached, press SCAN again to stop scanning.

Receiving RDS

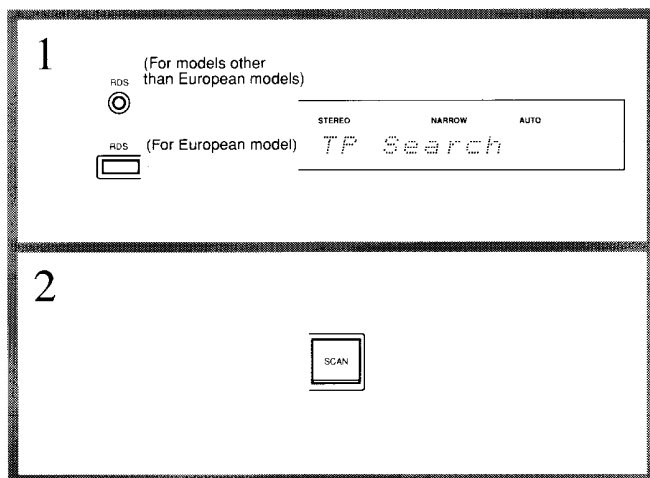

Receiving RDS traffic information

1. Press the RDS button until "TP Search" appears on the display.
2. Press the SCAN button to start searching for a TP station. When the unit receives a TP station, it stops scanning. If the unit cannot receive any signal, "Not find" (cannot find the station) is shown on the display.

NOTE:

If the TP indicator in the top left of the display lights up, the current station is broadcasting traffic information.



Searching for the station which sends the clearest and strongest signal. (AF search)

If the station you are listening to is not an RDS station, this search function cannot be used.

1. Press the RDS button until "AF Search" appears on the display.
2. Press the SCAN button to start searching for the strongest signal that this station can be received on.

If an AF list cannot be received, "No AF List" is shown on the display.

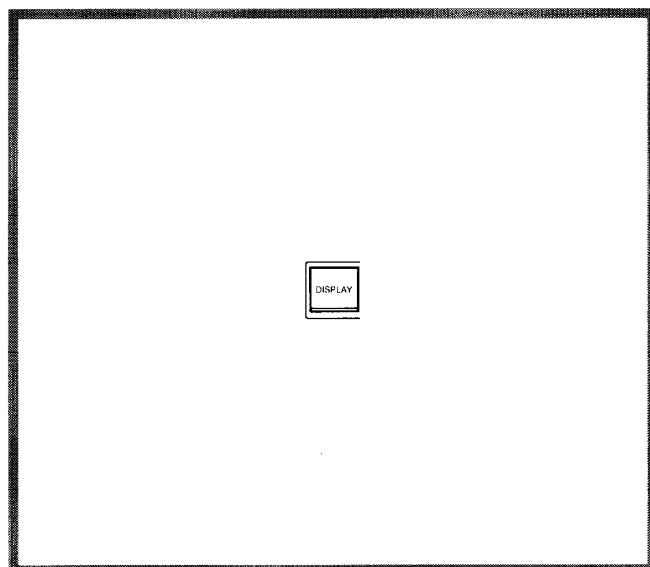

Displaying Radio Text (RT)

If the station you are listening to is not an RDS station, this function cannot be used.

1. Each time you press the DISPLAY button, the display changes as follows.

Depending on the radio station that you are listening to, some items are not displayed.

When an RDS station is being received:

→ Frequency → Program Service Name → Radio Text → Clock

When an RDS station is not being received:

→ Frequency → Character ("No Character" is displayed if characters have not been entered) → Clock

When RT is received, it can sometimes take between a few seconds and 15 seconds (more or less) to show RT on the display.

Sometimes the following messages will be shown on the display.

Wait Radio Text: indicates that it requires more time to receive the RT information. When the information is received, the characters will scroll across the display.

No Radio Text: this appears for 3 seconds and indicates that even though an RDS station is being received, there is no RT information included.

Entering characters

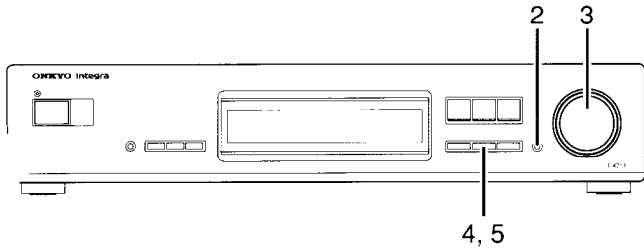

The following characters can be used.

□ ABCDEFGHIJKLMNOPQRSTUVWXYZ
 abcdefghijklmnopqrstuvwxyz!
 “ & % ’ () * + , - . / = ? : ; < > [] | @ \
 0 1 2 3 4 5 6 7 8 9

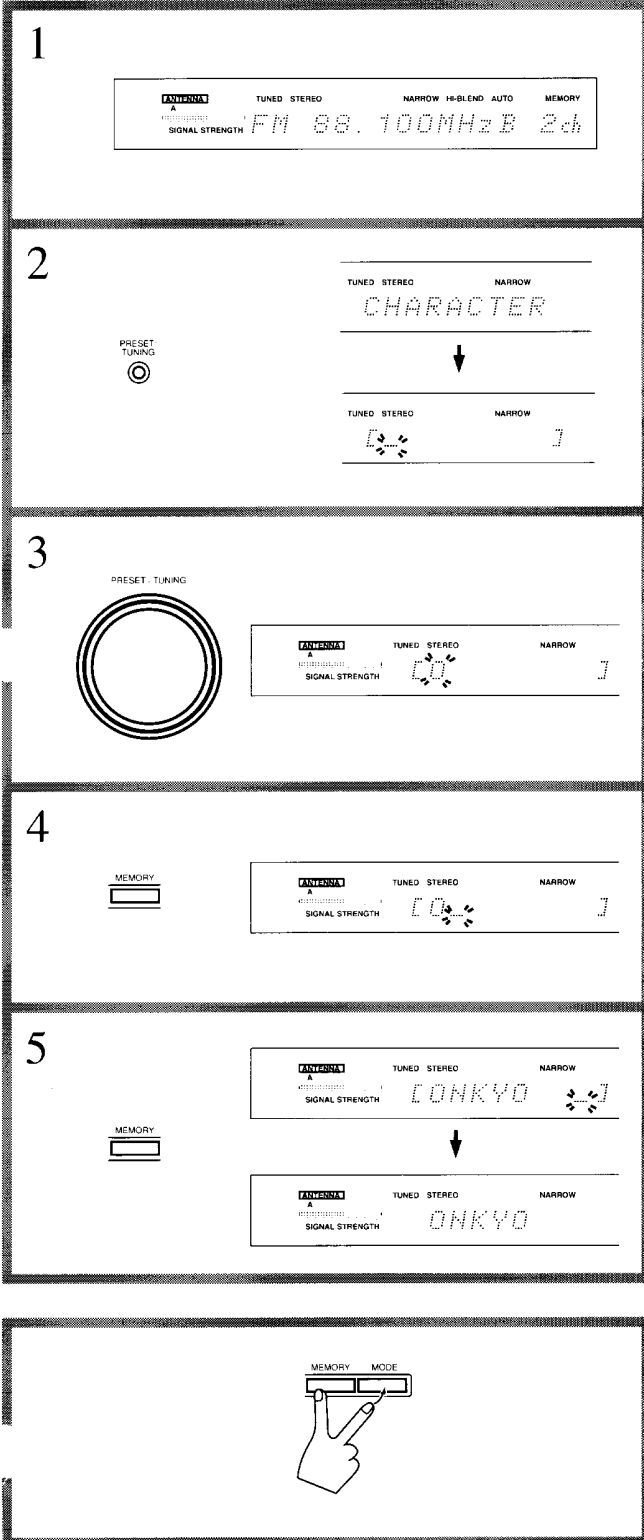

Entering new characters

If the station you are currently listening to on the T-4711 is an RDS station, the program service name has priority over other information. Therefore you will not be able to enter characters for the station name.

1. Select the station you wish to name (see previous sections).
2. Press the PRESET/TUNING button until Character Mode is selected.

With each press of the button, the mode changes one at a time in the following sequence:

→ PRESET → TUNING → CHARACTER

Continue pressing the PRESET/TUNING button until “PRESET” appears on the display.

After a few seconds, “[_]” appears on the display.

3. Use the PRESET/TUNING dial to select a character.
4. Press the MEMORY button to store the character. Repeat the procedures 3 and 4 to store more characters. You can store up to 8 characters in all. When you want to leave a space between characters, press the MEMORY button. The bar moves on to the next position.
5. Press the MEMORY button while the underline is at the eighth character position to finish entering characters.

NOTE:

- If you have not pressed a button for 16 seconds, the operation will complete automatically.
- Use the procedure mentioned above to change characters that have already been entered.

Changing the characters while they are being entered:

Before pressing the MEMORY button to finish entering the characters, press the PRESET/TUNING button to change the flashing “_” within the brackets to “←→”. Turn the PRESET/TUNING dial to move “←→” until it is at the character that you wish to change, then press the PRESET/TUNING button so that “_” appears. After using the PRESET/TUNING dial to select the correct character, press the MEMORY button to finish entering the characters.

Clearing all the characters stored in memory

1. After choosing the station whose characters you wish to clear, press the PRESET/TUNING button until Character Mode is selected.
2. When “[_]” appears on the display, hold down the MEMORY button and press the MODE button.

Setting the clock

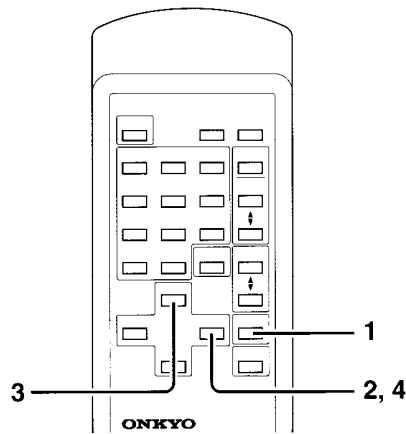

1

Remote control

ADJUST

ACCUClock On

2

Remote control

ENTER

FM 88.100MHz B

3

Remote control

TIMER

▲

TIMER PRESET

▼

FM 88.100MHz B

4

Remote control

ENTER

SUN 17:05 AUTO

↓

SUN 17:05 AUTO

This unit features "ACCUCLOCK"-an automatic clock adjusting feature using RDS broadcast signals.

Using the ACCUCLOCK function to set the clock (for remote control only)

NOTE:

- Before setting the clock, be sure to preset a station frequency.
- Make sure that your FM antenna has been properly connected as explained in page 7. It is strongly recommended that you install an outdoor FM antenna since the attached T-shaped FM antenna may not be able to receive RDS broadcasts well enough to allow ACCUCLOCK function properly.
- The clock will display the time in 24 hours. For example, 5:30 pm will be displayed as "17:30".

(Carry out the following procedure in STAND-BY.)

1. Press the **ADJUST** button until "ACCUCLOCK On (Off)" is displayed.

If "ACCUCLOCK Off" is displayed, press the ▲/▼ buttons until "ACCUCLOCK On" is displayed.

2. Press the **ENTER** button to display a preset station frequency.

3. Press the ▲/▼ buttons to tune in a station.

It is recommended to tune in a station with a clear reception.

4. Press the **ENTER** button.

The day and time appear on the display and "AUTO" flashes. After a short while, "AUTO" lights up.

After the clock is initially set, it will be adjusted periodically.

NOTE:

- Even if an RDS signal is present, the signal may not be strong enough to allow the ACCUCLOCK to automatically set the time. If this occurs, set the clock manually. (See page 17.)
- You may wish to adjust the clock yourself because the time information may differ depending on the RDS station detected. If so, follow the manual clock adjustment procedure described on page 17.
- There may be cases in which you can listen to radio broadcasts but cannot use the ACCUCLOCK function.

If ACCUCLOCK cannot be used:

Repeat step 1. above to display "ACCUCLOCK Off" and turn off ACCUCLOCK.

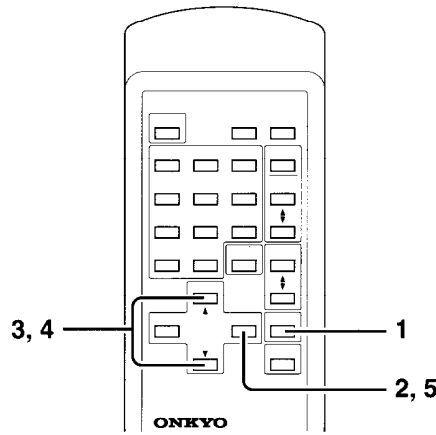

1
Remote control
ADJUST
Manual Adjust

2
Remote control
ENTER
SUN 0:00

3
Remote control
TIMER
TIMER PRESET
WED 0:00
Remote control ENTER

4
Remote control
TIMER
TIMER PRESET
WED 17:05

5
Remote control
ENTER
WED 17:05

Setting the clock manually

You may wish to set the clock manually if the ACCUCLOCK cannot receive RDS signals, if the displayed time is obviously wrong, or if you wish to set your own time (you may intentionally advance the clock) by doing the following:

1. Press the ADJUST button until "Manual Adjust" is displayed.
2. Press the ENTER button to display the day and time.
 - If an RDS broadcast was tuned in and the CT information was already received, the day and time will be displayed. To use the currently set day and time, skip to step 5.
3. Press ▲ or ▼ button until the desired day of the week is selected, and then press the ENTER button.
 - The days can also be entered using the number buttons. If the number buttons are used:
 1: Sunday 2: Monday 3: Tuesday 4: Wednesday
 5: Thursday 6: Friday 7: Saturday
4. Set the desired time by using the ▲ or ▼ button.
 - The time can also be entered using the number buttons. For example to enter "17:05", press 1, then 7, then 0/10, and then 5.
5. Press the ENTER button.
The clock will start operating.

NOTE:

If ACCUCLOCK mode is turned on, even if the clock is set manually, ACCUCLOCK will continue adjusting the clock automatically. Refer to "If ACCUCLOCK cannot be used:" on the previous page to turn off ACCUCLOCK.

Using the main unit to set the clock:

1. In stand-by mode, press the MEMORY button.
2. When the day flashes, use the PRESET/TUNING dial to set the day.
3. Press the MEMORY button.
4. When "0:00" flashes, use the PRESET/TUNING dial to set the time.
5. Press the MEMORY button.

Using the timer (for remote control only)

The remote control can be used to set the following four timer functions.

- WeekDay:** For listening to the radio at a designated time on weekdays.
- WeekEnd:** For listening to the radio at a designated time on weekends.
- Once:** For listening to the radio at a designated time one time only.
- Sleep:** Power off the system after a specified time period.

NOTE:

- Make sure that the clock has been set correctly before setting the timer.
 - Before setting the timer, be sure the amplifier's volume control and input selector are set to the desired positions.
 - In order to use the timer to switch on and off other components (such as a CD player or cassette deck), connect the components to this unit's AC outlets.
- Refer to the Instruction Manuals of the other components for more details on their operation.

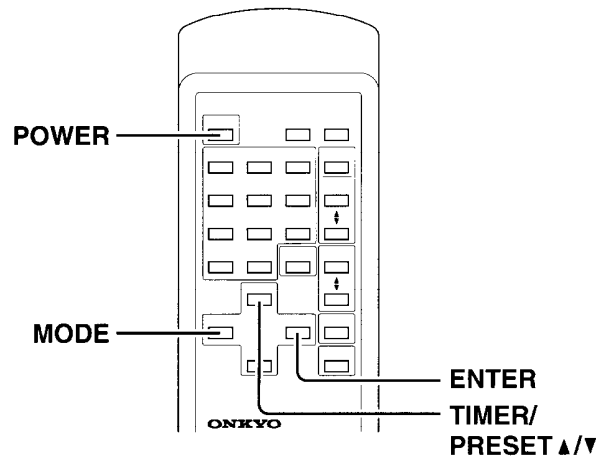

1

Remote control

2

Remote control

3

Remote control

4

Remote control

Starting playing at a selected time

Before using the timer to listen to a radio broadcast, preset the station frequency. (See "Receiving stations" on pages 10 and 11 for details on how to preset FM/AM stations.)

1. Press the **TIMER "MODE" button** until "WeekDay", "WeekEnd" or "Once" is displayed. At this time, "On" or "Off" flashes and the corresponding indicator on the left side of the display lights up.
2. Press the **▲/▼ buttons** to set "On".
3. Press the **ENTER button**.

If "Once" was selected in step 1., skip to step 4.
 If "WeekDay" or "WeekEnd" were selected in step 1., enter the day settings.
 The initial settings for "WeekDay" are Monday, Tuesday, Wednesday, Thursday and Friday and the settings for "WeekEnd" are Saturday and Sunday.

To leave the settings as they are:

Press the ENTER button.

To change the days:

1. After three seconds, the letter for Sunday begins flashing
 2. Use the **▲/▼ buttons** to either make the letter light up or go off.
 3. Press the **ENTER button** to move to the next day.
- When all the settings are entered, continue to step 4.

4. Press the **▲/▼ buttons** to set the ON time, then press the **ENTER button**.
 The initial ON time is 0:00. Enter your desired ON time.

(Continued on page 19)

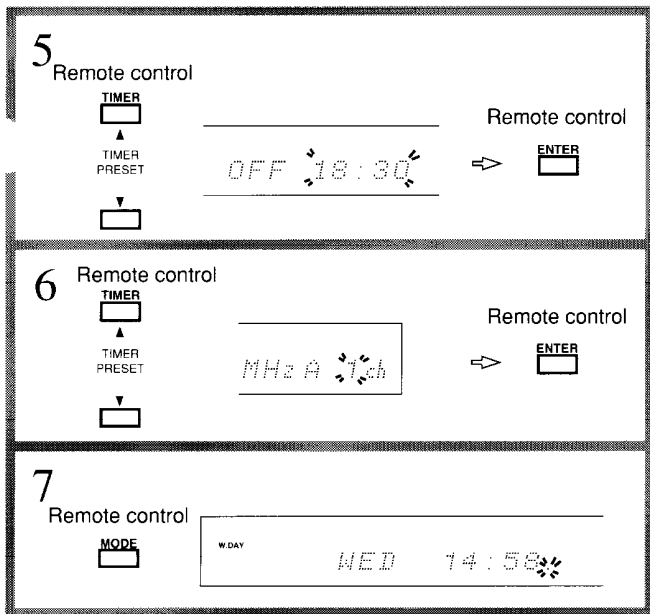

5. Press the ▲/▼ buttons to set the OFF time, then press the ENTER button.

After entering the ON time, the unit will suggest an OFF time of one hour after the entered ON time.

6. Press the ▲/▼ buttons to set the preset station number, then press the ENTER button.

7. Turn off the power.

When the ON time has come, the timer starts playing the preset radio broadcast. When the OFF time has come, the timer automatically turns off the unit's power. If "WeekDay" or "WeekEnd" were selected, the power is turned on and off at the set times on the selected days. If "Once" was selected the power is turned on and off at the set times, then the setting is cancelled.

NOTE:

If the same time is set for the ON and the OFF times, or the WeekDay and WeekEnd day settings are all turned off, the timer cannot be set. (The small timer indicator goes off.)

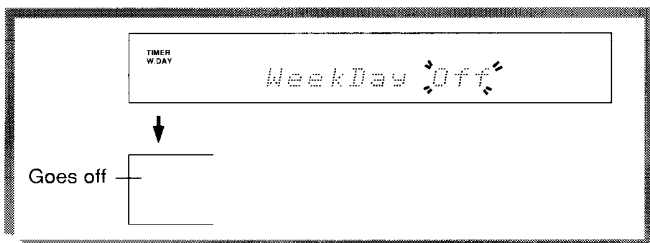

Turning off the timer

Repeat step 2. above to turn off the function. The indicator at the left of the display goes off.

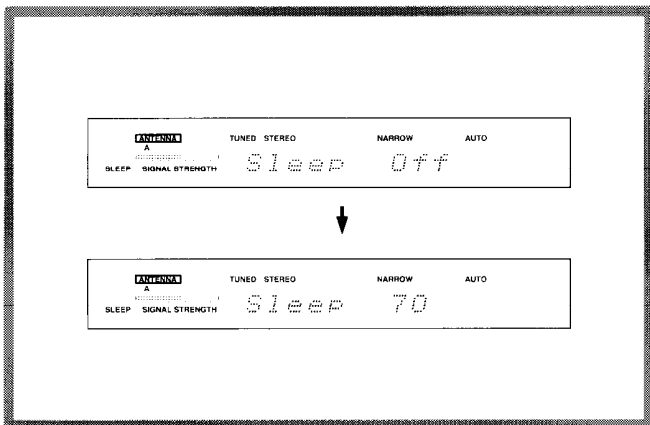

Setting the sleep function

When listening to a radio broadcast,

1. Press the TIMER "MODE" button until "Sleep Off" is displayed.

2. Press the ENTER button until the desired sleep time (90 to 10 in 10 minute) is set.

After the specified length of time, the power will be switched off automatically.

To confirm the remaining time:

Press the ENTER button.

To cancel the sleep setting:

Press the ENTER button until the sleep setting is turned off (the sleep time is not displayed).

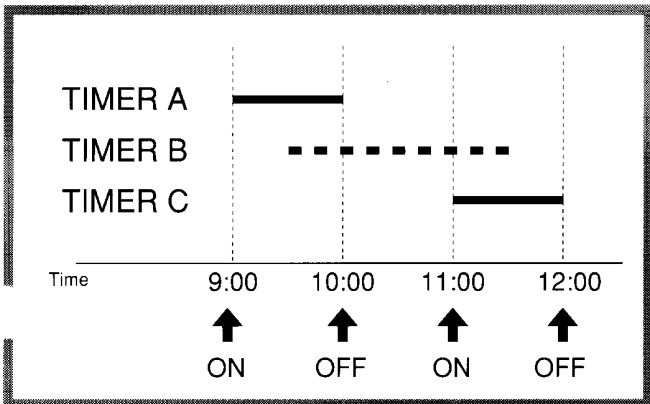

Notes to timer setting

- Make sure that the clock has been set correctly before setting the time.
- After setting the timer, be sure to set the power off. When the power is on, the timer does not activate even at the ON time.
- When the power is on with the timer, the other timers do not activate at the ON time. The power will be switched off at the first timer's OFF time. (See figure.)
- If the SLEEP is set during timer play, the power will be switched off at the sleep timer's OFF time.
- If more than two timer settings are made at the same time, the "W. Day" setting has the first priority and the "W. End" setting has the second one. "Once" setting has no priority.

Specifications

FM

Tuning Range:	European and Worldwide models: 87.50 – 108.00 MHz (50 kHz steps) USA and Canadian models: 87.90 – 107.90 MHz (200 kHz steps)
Usable Sensitivity:	Mono: 10.3 dBf 0.9 μ V, 75 Ohms IHF 0.8 μ V, 75 Ohms DIN Stereo: 17.2 dBf 2.0 μ V, 75 Ohms IHF 20 μ V, 75 Ohms DIN
50 dB Quieting Sensitivity:	Mono: 16.1 dBf 1.7 μ V 75 Ohms Stereo: 36.1 dBf 17 μ V 75 Ohms
Capture Ratio:	1.3 dB
Image Rejection Ratio:	100 dB
IF Rejection Ratio:	100 dB
Signal-to-Noise Ratio:	Mono: 85 dB IHF Stereo: 77 dB IHF 70 dB IHF (Narrow)
Selectivity:	70 dB DIN (\pm 300 kHz, 40 kHz dev.)
AM Suppression Ratio:	50 dB
Total Harmonic Distortion:	Mono: 0.1% 0.3% (Normal 40 kHz dev.) Stereo: 0.2% 0.7% (Normal 40 kHz dev.)
Frequency Response:	30 – 15,000 Hz (+0.5, -1.0 dB)
Stereo Separation:	45 dB at 1 kHz 33 dB at 70 – 10,000 Hz
Output Voltage:	1.0 V
Muting Level:	17.2 dBf 2.0 μ V, 75 Ohms

AM

Tuning Range:	USA and Canadian models: 530 – 1710 kHz (10 kHz steps) Worldwide models: 531 – 1602 kHz (9 kHz steps) 530 – 1710 kHz (10 kHz steps)
Usable Sensitivity:	25 μ V
Image Rejection Ratio:	40 dB
IF Rejection Ratio:	40 dB
Signal-to-Noise Ratio:	40 dB
Total Harmonic Distortion:	0.8%
Output Voltage:	250 mV

General

Power Supply:	USA and Canadian models: AC 120 V, 60 Hz European models: AC 230 V, 50 Hz Worldwide models: AC 120 V and 220 – 230 V switchable, 60/50 Hz
Dimensions (W \times H \times D):	435 \times 91 \times 373 mm 17-1/8" \times 3-9/16" \times 14-11/16"
Mass:	4.9 kg, 10.8 lbs.

Specifications and features are subject to change without notice.

Troubleshooting Guide

- **No power.**
Cause: Power cord is disconnected.
Remedy: Connect power cord.
- **Buzzing noise on AM, usually conspicuous at night or with a weak station. (For models other than European models)**
Cause: Noise from electrical apparatus such as fluorescent lamps.
Remedy: Move set to different location.
Remedy: Change the position or direction of the loop antenna.
- **High pitch noise.**
Cause: Noise from TV.
Remedy: Keep unit away from TV set.
- **Crackling noise on AM and FM.**
Cause: Noise caused by turning a fluorescent lamp on and off.
Remedy: Move the antenna as far away as possible from the fluorescent lamp.
Cause: Noise from automobile ignition.
Remedy: Install an outdoor FM antenna as far away as possible from the road.
- **AM stations cannot be received. (For models other than European models)**
Cause: AM loop antenna is not attached.
Remedy: Connect the included AM loop antenna to the AM antenna terminals.
- **TUNED indicators and stereo indicator light but sound is distorted and separation is bad.**
Cause: Station is too strong.
Remedy: Change to T-shaped antenna.
Cause: Multiple reflection of the radio waves because of tall buildings or mountains.
Remedy: Use antenna which has better directivity and select a point with the least distortion.
- **TUNED indicators and stereo indicator flicker and hiss is heard on FM.**
Cause: Station is too weak.
Remedy: Install an outdoor FM antenna.
Remedy: Change the position or direction of the outdoor antenna.
Cause: Stereo FM broadcasts cover only about half the distance of an ordinary broadcast.
Remedy: Switch to mono reception. (Even stereo broadcasts will be heard in mono.)
- **No station or undesired station is recalled.**
Cause: The power cord has been unplugged for a long time.
Remedy: The memory contents are lost if the power is not turned on and off a few times each month. Store all stations in the memory again and remember to turn power on and off a few times each month.
- **The RDS function does not work.**
Cause: The station is not an RDS station.
Remedy: Receive an RDS station.
Cause: The reception station signal is too weak.
Remedy: Install an outdoor FM antenna.
Remedy: Change the position or direction of the outdoor antenna.
Cause: Too much interference.
Remedy: Move the antenna as far away as possible from fluorescent lamps.
Remedy: Install an outdoor FM antenna.
- **ACCUCLOCK function does not work.**
Cause: The station is not an RDS station, or received signal is too weak.
Remedy: See the remedies for the RDS function problem above.
Cause: RDS broadcasts cannot be received.
Remedy: Set and adjust according to instructions above.
- Excessive electrical interference may temporarily render this system's sensitive microcomputer inoperable. If this happens, unplug the system for at least five seconds.

ONKYO CORPORATION

Sales & Product Planning Div. : 2-1, Nisshin-cho, Neyagawa-shi, OSAKA 572, JAPAN
Tel: 0720-31-8111 Fax: 0720-33-5222

ONKYO U.S.A. CORPORATION

200 Williams Drive, Ramsey, N.J. 07446, U.S.A.
Tel: 201-825-7950 Fax: 201-825-8150 E-mail: onkyo@onkyousa.com

ONKYO EUROPE ELECTRONICS GmbH

Industriestrasse 18-20, 82110 Germering, GERMANY
Tel: 089 84 93 20 Fax: 089 84 93 226

ONKYO FRANCE

Immeuble Le Diamant, Domaine Technologique de Saclay, 4 Rue René Razel,
91892 SACLAY, FRANCE Tel: (1) 69 33 14 00 Fax: (1) 69 41 35 84

